

# Designer Dress

Here is a simple design for a wedding dress. The bride would like you to decorate it. Think about the materials you could use on a real dress - pearls, sequins, embroidery.

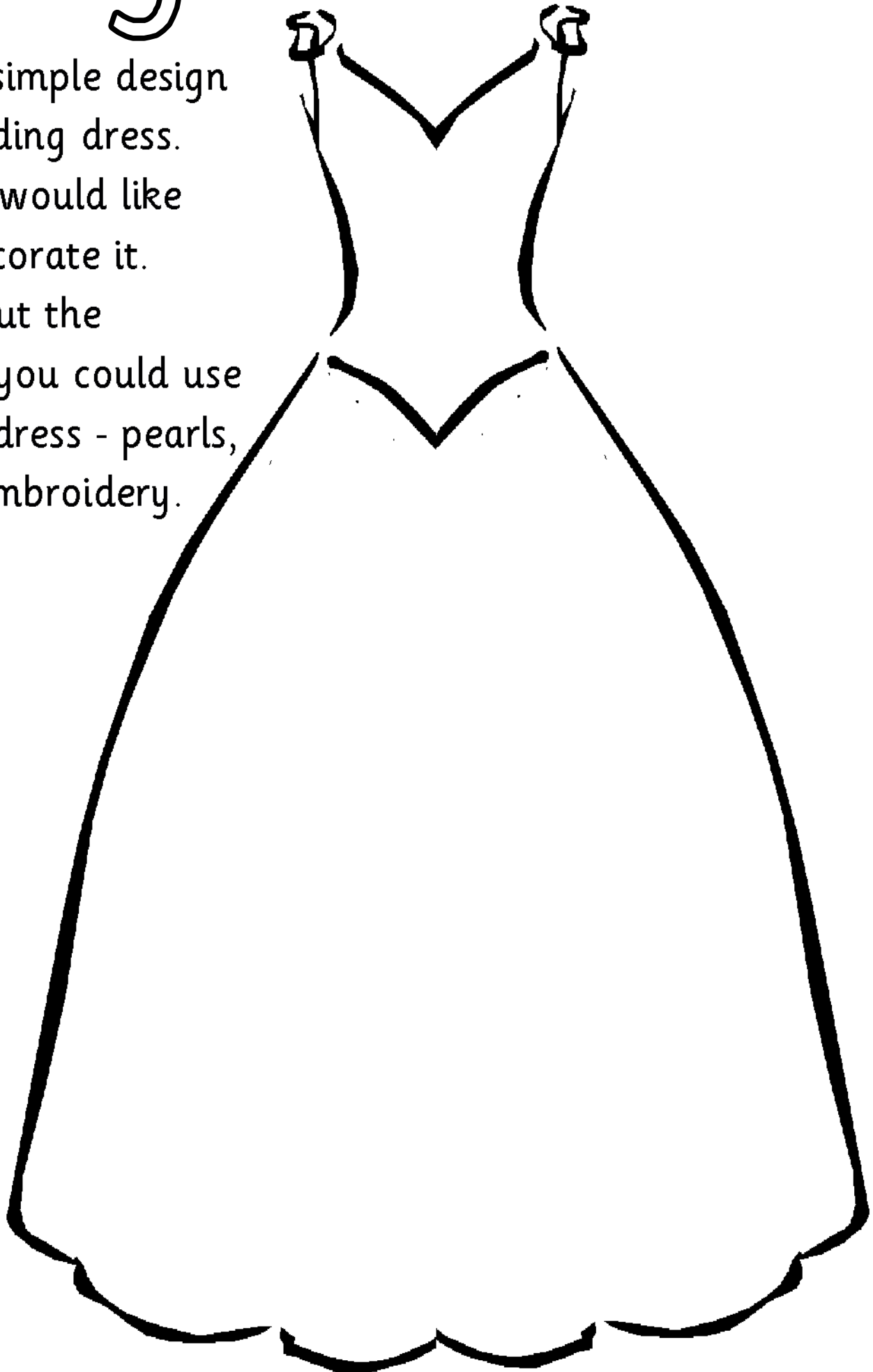

# Designer Dress

The bride loves symmetry.  
Can you design her dress so that it is symmetrical?

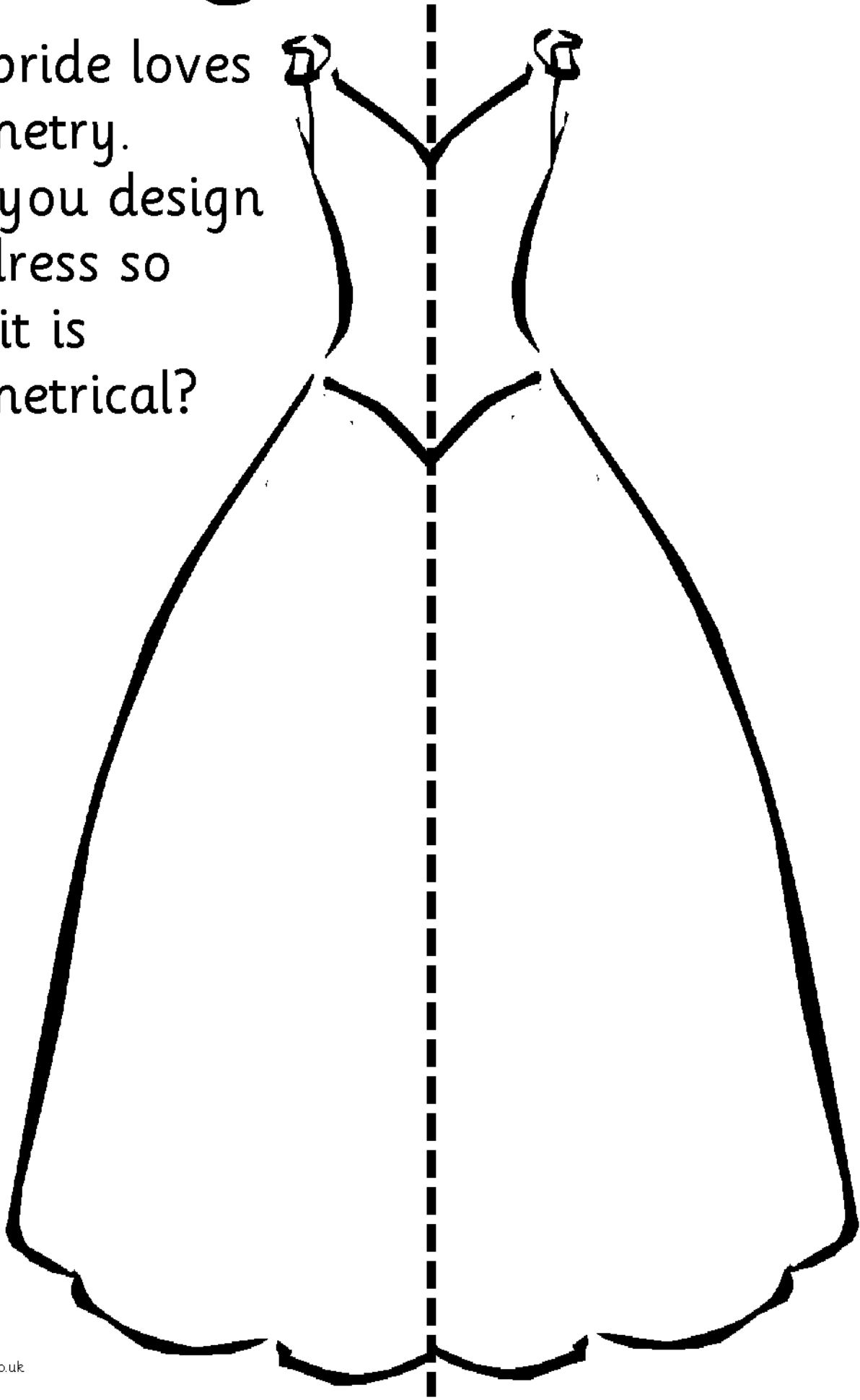

# Design a Plate

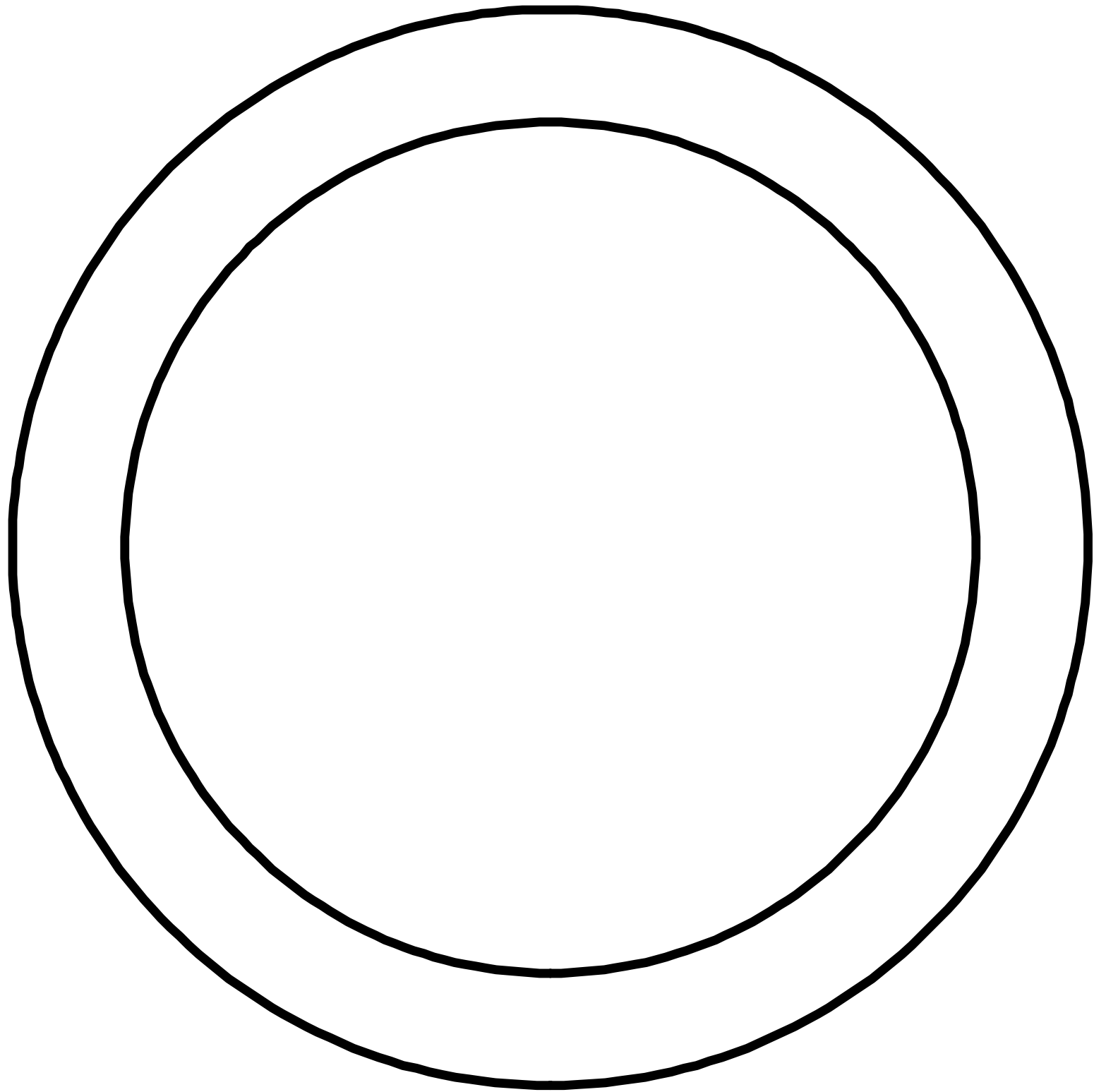

You have been asked to design a plate to commemorate the royal wedding. What information do you need to include?

# Design a Tiara

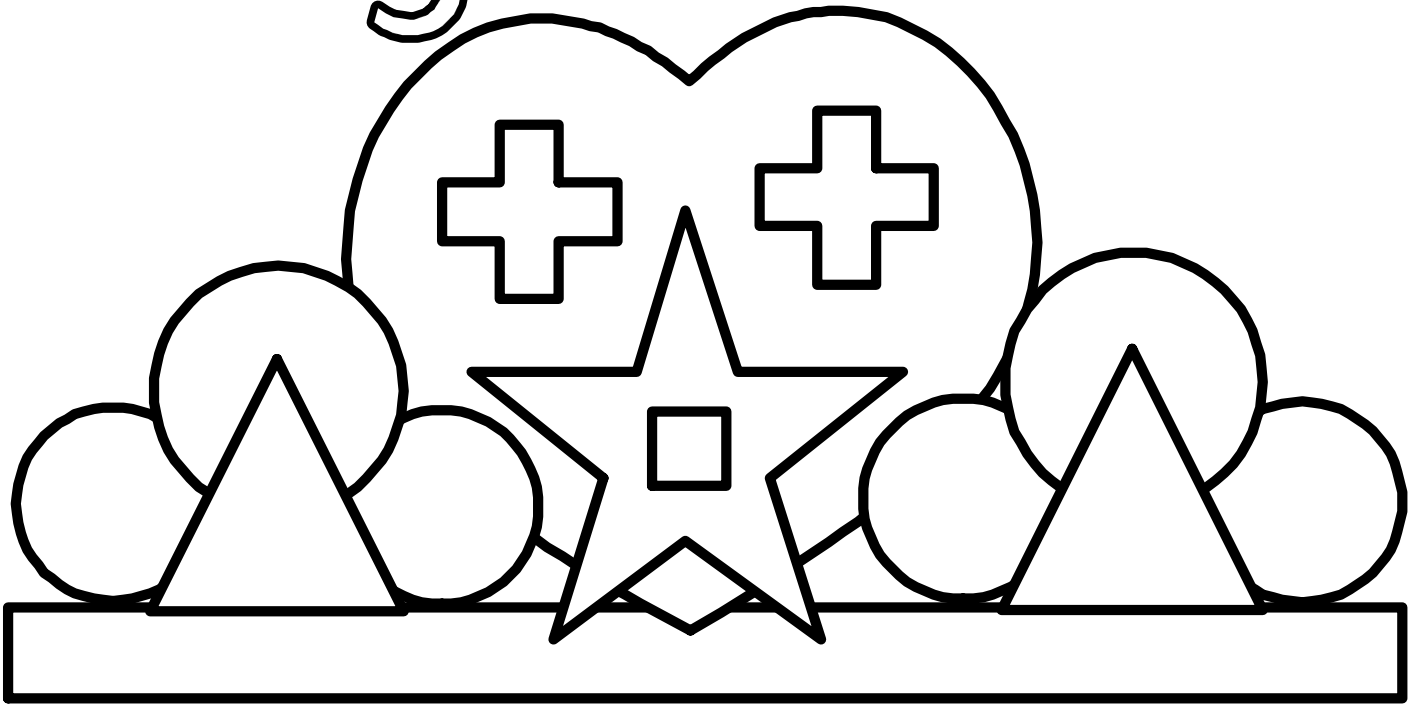

What shapes have been used to make this tiara? Try designing your own tiara below.



# Design a Tiara

Try designing your own tiara below.



# Design a Tiara

Try designing your own symmetrical tiara below.

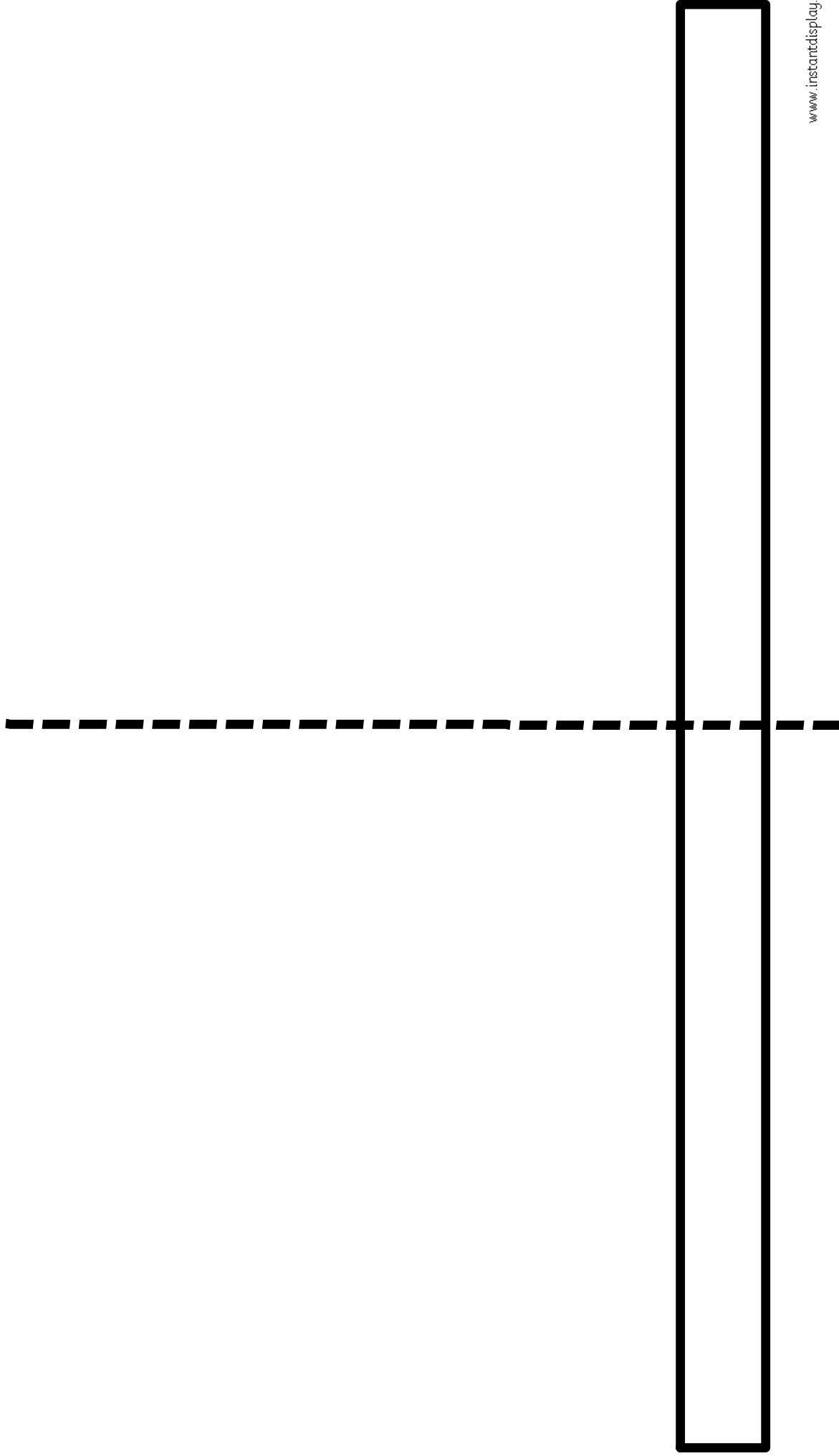

# Design a Cake

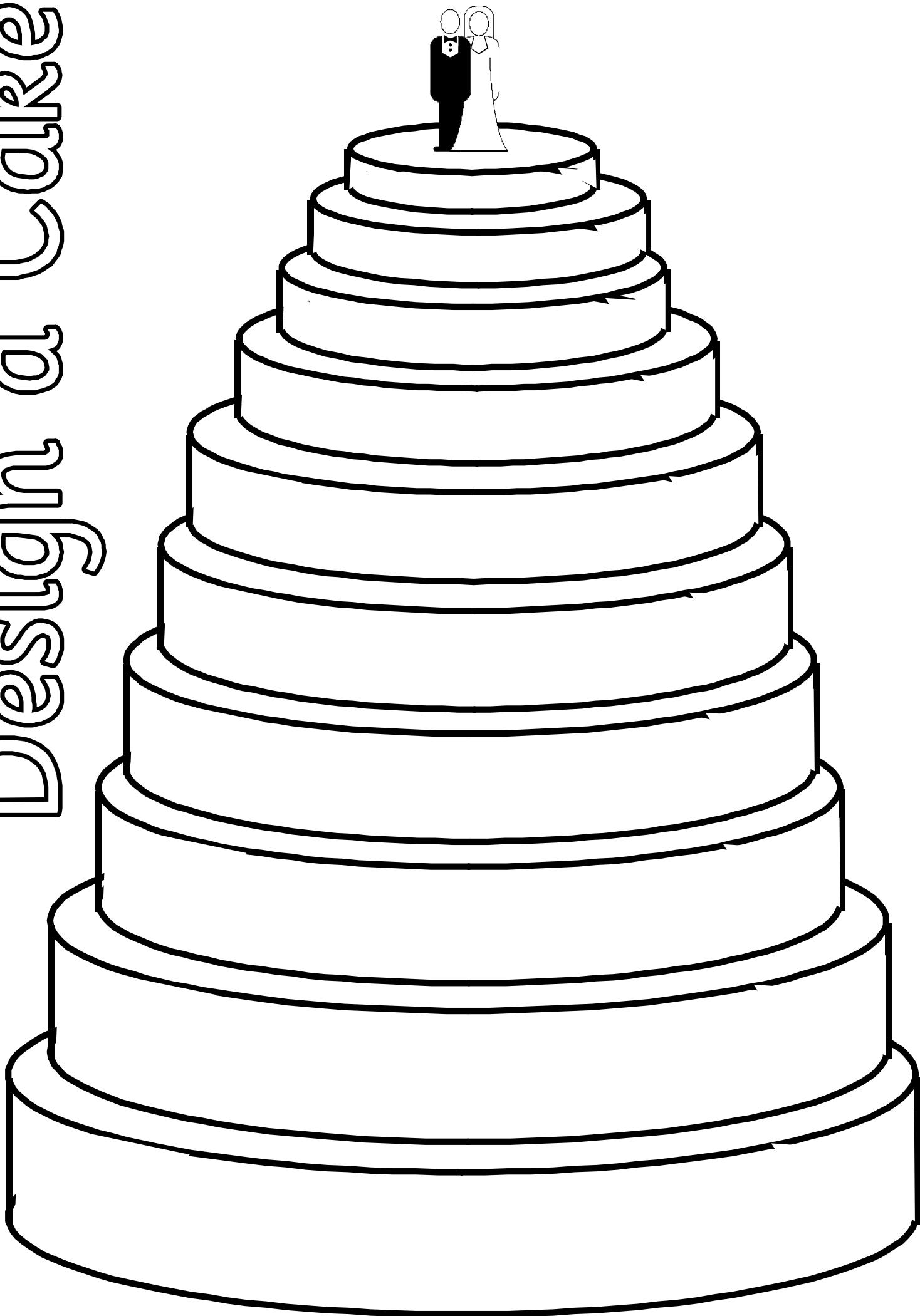

# Design a Cake

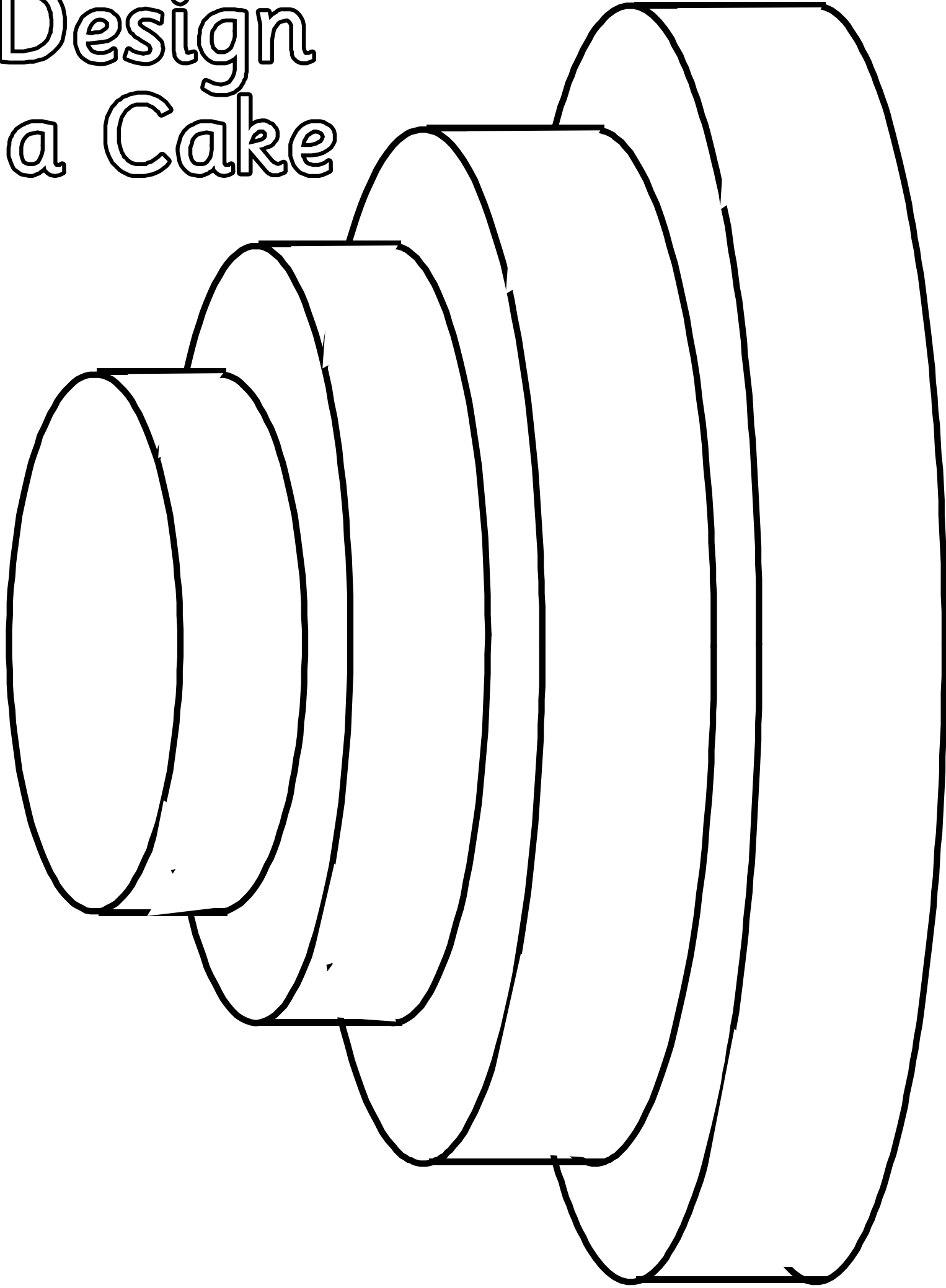



# Design a Cake

